

4 Specifications

Spécifications/Spesifikationer/Specifiche/
Especificaciones/Specificaties/Especificações/
Спецификация/Özellikler/Specyfikacja

Brigade

www.brigade-electronics.com

AHD

Brigade

SS-H002

Quick installation guide
Guide d'installation rapide
Kurzanleitung
Guida d'installazione rapida
Guía de Instalación Rápida
Snelle installatie handleiding
Guia de instalação rápida
Руководство по быстрой установке
Skrócona instrukcja obsługi
Hızlı başlangıç Kilavuzu

EN Specifications	
TV system	NTSC/PAL AHD 1.0 (720p - 25/50/30/60 fps) AHD 2.0 (1080p - 25/30fps)
Current consumption	≤1.80A @ 12Vdc
Power	12~24Vdc input
Inputs	2 x camera
Dimensions	147(w) x 37(h) x 78(d)mm 5,8(w) x 1,46(h) x 3,0(d) inches
Operating temperature	-30°C - +80°C / -22°F - +176°F

DE Spezifikationen	
TV-System	NTSC/PAL AHD 1.0 (720p - 25/50/30/60 fps) AHD 2.0 (1080p - 25/30fps)
Stromverbrauch	≤1.80A @ 12Vdc
Stromaufnahme	12~24Vdc input
Eingänge	2 x Kamera
Abmessungen	147(w) x 37(h) x 78(d)mm 5,8(w) x 1,46(h) x 3,0(d) inches
Betriebstemperatur	-30°C - +80°C / -22°F - +176°F

ES Especificaciones	
Sistema de TV	NTSC/PAL AHD 1.0 (720p - 25/50/30/60 fps) AHD 2.0 (1080p - 25/30fps)
Consumo de corriente	≤1.80A @ 12Vdc
Suministro de corriente	12~24Vdc input
Inputs	2 x cámara
Dimensiones	147(w) x 37(h) x 78(d)mm 5,8(w) x 1,46(h) x 3,0(d) inches
Temperatura de servicio	-30°C - +80°C / -22°F - +176°F

PT Especificações	
Sistema de TV	NTSC/PAL AHD 1.0 (720p - 25/50/30/60 fps) AHD 2.0 (1080p - 25/30fps)
Consumo actual	≤1.80A @ 12Vdc
Fornecimento de corrente	12/24Vdc entrada
Entradas	2 x câmara
Dimensões	147(w) x 37(h) x 78(d)mm 5,8(w) x 1,46(h) x 3,0(d) polegadas
Temperatura de serviço	-30°C - +80°C / -22°F - +176°F

TR Özellikler	
Tv Sistemi	NTSC/PAL AHD 1.0 (720p - 25/50/30/60 fps) AHD 2.0 (1080p - 25/30fps)
Güç sarfı	≤1.80A @ 12Vdc
Besleme	12~24Vdc input
Girişler	2 x kamera
Ebatlar	147(w) x 37(h) x 78(d)mm 5,8(w) x 1,46(h) x 3,0(d) inches
Çalışma sıcaklığı	-30°C - +80°C / -22°F - +176°F

FR Specifications	
Système TV	NTSC/PAL AHD 1.0 (720p - 25/50/30/60 fps) AHD 2.0 (1080p - 25/30fps)
Consommation en courant	≤1.80A @ 12Vdc
Alimentation	12~24Vdc input
Entrées	2 x camera
Dimensions	147(w) x 37(h) x 78(d)mm 5,8(w) x 1,46(h) x 3,0(d) inches
Température d'utilisation	-30°C - +80°C / -22°F - +176°F

IT Specifiche	
Sistema TV	NTSC/PAL AHD 1.0 (720p - 25/50/30/60 fps) AHD 2.0 (1080p - 25/30fps)
Consumo di corrente	≤1.80A @ 12Vdc
Alimentazione	12~24Vdc input
Ingressi	2 x camera
Dimensioni	147(w) x 37(h) x 78(d)mm 5,8(w) x 1,46(h) x 3,0(d) inches
Temperature d'esercizio	-30°C - +80°C / -22°F - +176°F

NL Specificaties	
TV-systeem	NTSC/PAL AHD 1.0 (720p - 25/50/30/60 fps) AHD 2.0 (1080p - 25/30fps)
Huidig verbruik	≤1.80A @ 12Vdc
Stroomvoorziening	12~24Vdc Ingang
Ingangen	2 x camera
Afmetingen	147(w) x 37(h) x 78(d)mm 5,8(w) x 1,46(h) x 3,0(d) inches
Bedrijfstemperatuur	-30°C - +80°C / -22°F - +176°F

RU Спецификация	
ТВ-система	NTSC/PAL AHD 1.0 (720p - 25/50/30/60 fps) AHD 2.0 (1080p - 25/30fps)
Потребляемый ток	≤1.80A @ 12Vdc
Напряжение затраты	12/24Vdc затраты
затраты	2 x камеры
размеры	147(ш) x 37(в) x 78(г)мм 5,8(ш) x 1,46(в) x 3,0(г) дюймов
Рабочая температура	-30°C - +80°C / -22°F - +176°F

PL Dane techniczne	
System TV	NTSC/PAL AHD 1.0 (720p - 25/50/30/60 fps) AHD 2.0 (1080p - 25/30fps)
Napięcie prądu	≤1.80A @ 12Vdc
Zasilanie	12~24Vdc input
Wejścia	2 x kamera
Wymiary	147(w) x 37(h) x 78(d)mm 5,8(w) x 1,46(h) x 3,0(d) inches
Zakres temperatur	-30°C - +80°C / -22°F - +176°F

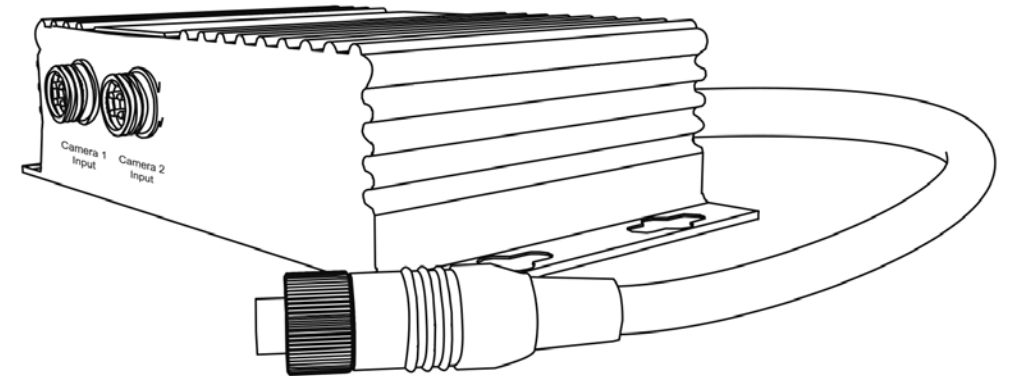

IG No: 7180

1 Contents

Contenu/Inhalt/Contenuti/Contenidos/inhoud/Conteúdo/Содержание/Zawartość/İçerik

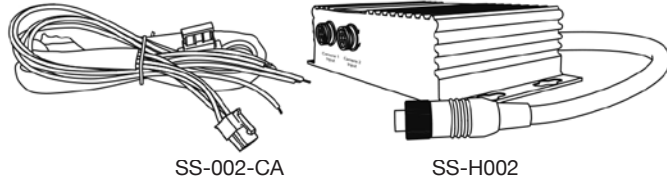

2 Connections

Connexions/Anschlüsse/Connessioni/Conexiones/Aansluitingen/Conexão/Соединения/Podłączenie/Bağlantılar

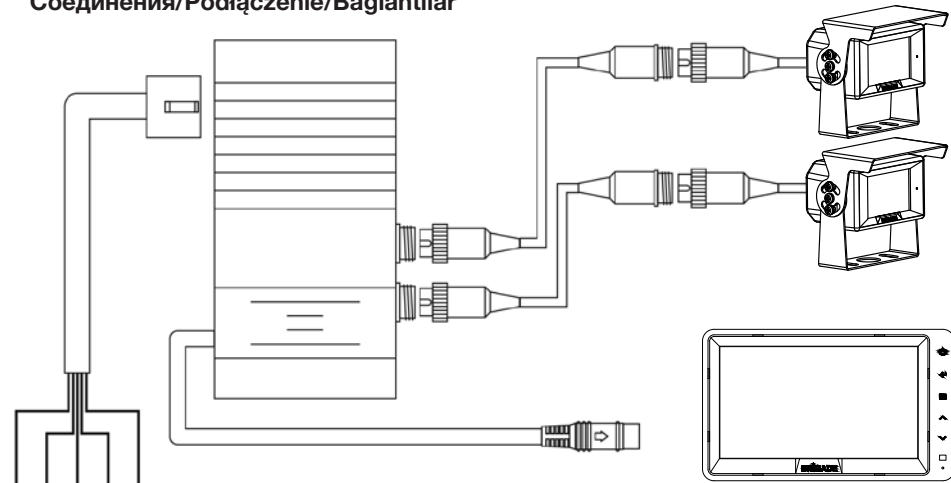

5 4 3 2 1

Red Power
Rouge Positif
Rot Betriebsspannung
Rosso Positivo
Rojo Positivo
Rood Vermogen
Vermelho Positivo
красный мощность
Czerwony Zasilanie
Kırmızı Arti

4

Black Ground
Noir Masse
Schwarz Masse
Nero Massa
Negro Masa
Zwart Grond
Preto Massa
черный заземление
czarny Masa
Siyah Eksi

5

Trigger
Déclencher
Trigger
Attivazione
Desencadenar
Trekker
Gatilho
триггер
Wyzwalacz
Tetik

White
Blanc
Weiss
Bianco
Blanco
Wit
Branco
белый
Biały
Beyaz

CA1

Blue
Bleu
Blau
Blu
Blauw
Azul
Azul
синий
Niebieski
Mavi

CA2

Brown
Brun
Braun
Marrone
Marrón
Bruin
Marrom
коричневый
Brązowy
Kahverengi

3

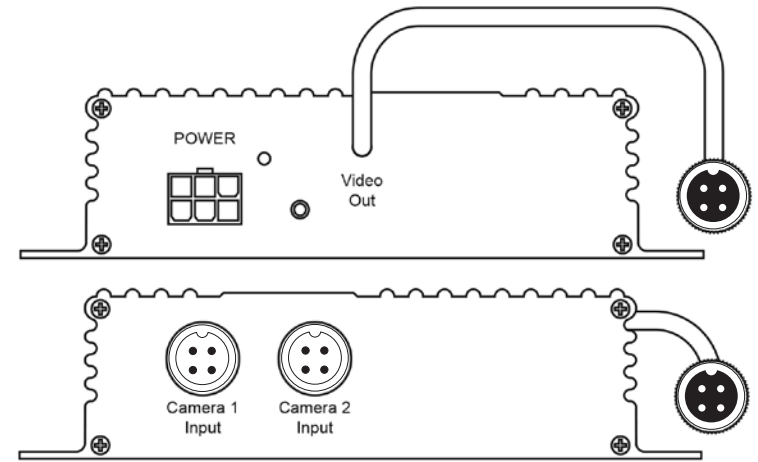

3 Operation

Opération/Betrieb/Funzionamento/Operación/Werking/Operação/Операция/Ayarlama/Działanie

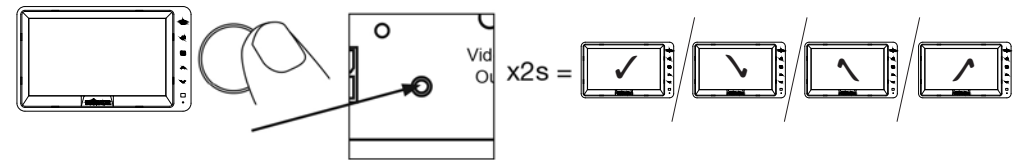
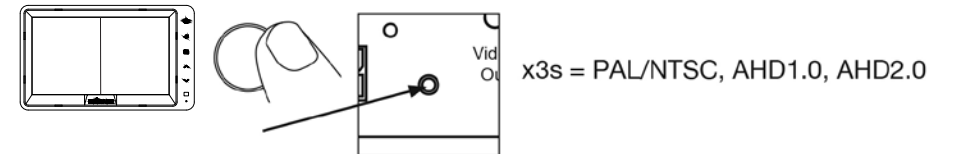
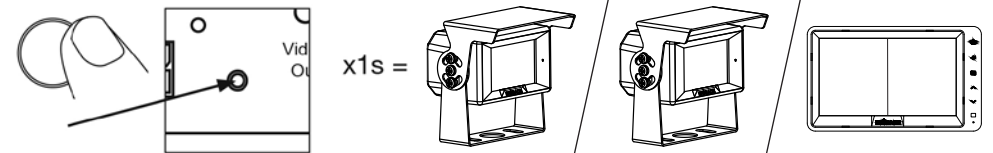

Factory Reset/Réinitialisation d'usine/Werkseinstellungen/Reset di fabbrica/Restablecimiento de fábrica/Fabrieksherstel/Reinicialização de Fábrica/Заводской сброс/Fabrika Ayarlarına Sıfırlama/Reset fabryczny

